

LEGENDE

-  Emplacement Lave Linge
-  Emplacement Lave Vaisselle
-  Emplacement Lave Linge ou Lave Vaisselle
-  Emplacement Cuisson
-  Emplacement Réfrigérateur
-  Tableau Electrique
-  Panneau Rayonnant
-  Sèche Serviette
-  Baie Couissante
-  Porte Fenêtre
-  Fenêtre
-  Fenêtre à Allège Vitrée
-  Volet Roulant
-  Prise Télévision
-  Placard
-  Soffite / Faux Plafond
-  Gaine Technique
-  Chauffe Eau
-  Pompe à Chaleur
-  Attente Lave Linge supplémentaire
-  Groupe(s) Extérieur(s)
-  Module Thermique d'Appartement
-  Brasseur d'air

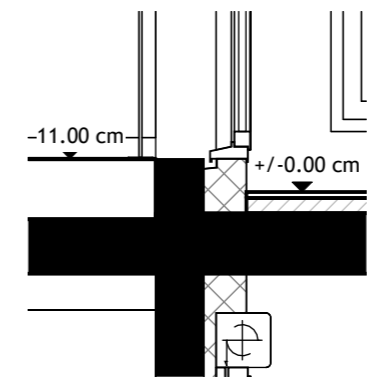
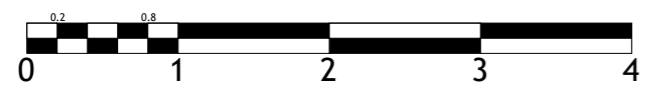
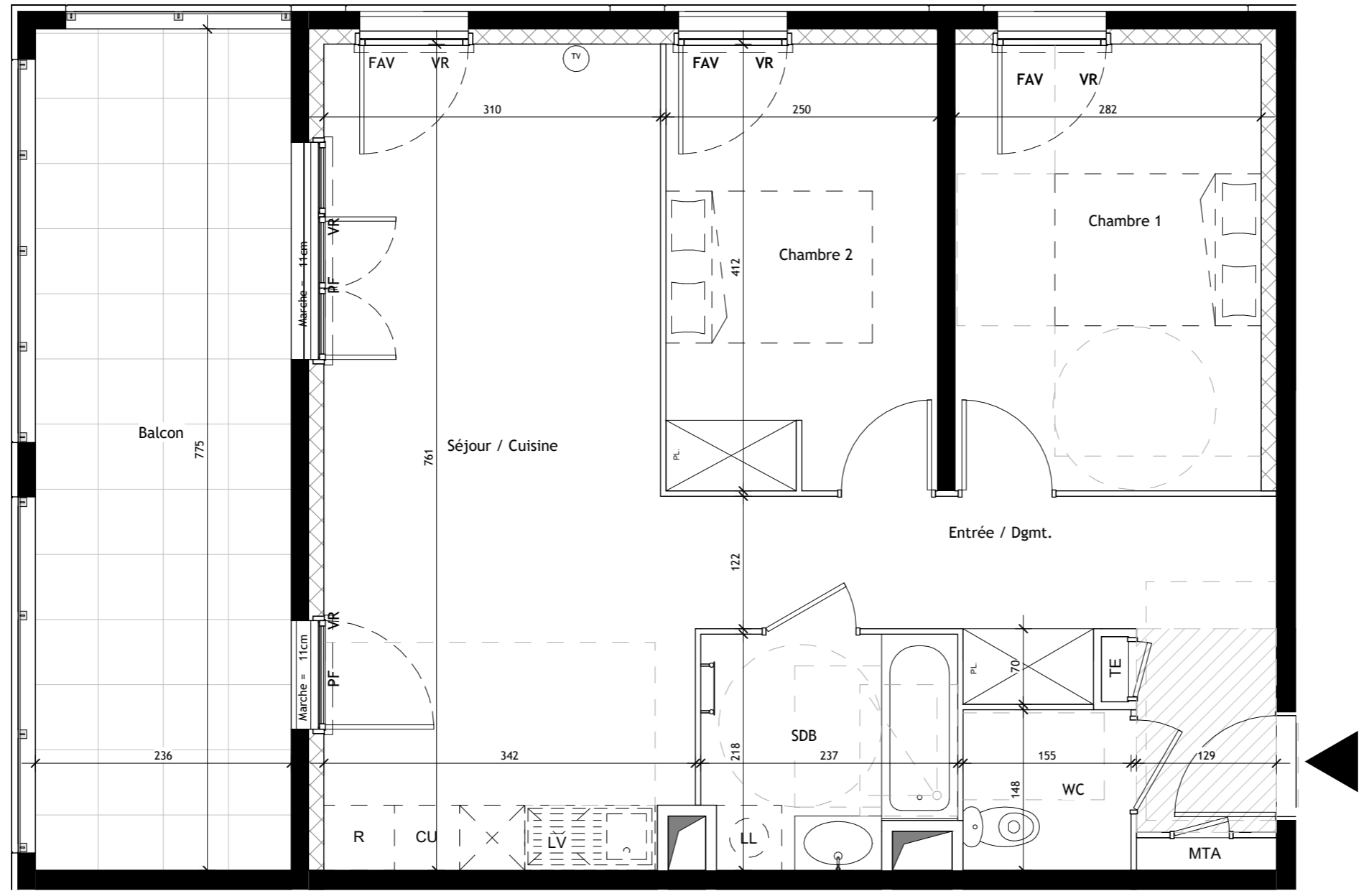

COCOON

Castelnau-le-Lez



BÂTIMENT : B	Type : T3
Niveau : R+4	N° : B42

TABLEAU DES SURFACES	
Chambre 1	11.60 m ²
Chambre 2	10.26 m ²
Entrée / Dgmt.	10.02 m ²
SDB	4.74 m ²
Séjour / Cuisine	25.09 m ²
WC	2.29 m ²
SURFACE HABITABLE	64.00 m²
Balcon	18.26 m²

PLAN DE VENTE

SCCV EUREKA LOT 17B
 1475 Av Albert Einstein
 34000 Montpellier
 07 57 60 98 14
 contact@cocoonresidence.com

Indice : D	Date : 01/04/2026
------------	-------------------

NOTA :

- Des modifications sont susceptibles d'être apportées à ce plan en fonction des nécessités techniques ou réglementaires lors de la réalisation
- Les surfaces indiquées sont approximatives conformément à l'article R261-25 du CCH
- Les retombées, soffites, faux plafonds, gaines, canalisations, convecteurs, l'emplacement des équipements électriques, ainsi que la hauteur sous plafond des seuils et la hauteur des seuils et allèges sont figurés à titre indicatif.
- Les plantations éventuelles ne sont pas contractuelles. Le mobilier ainsi que l'emplacement des éléments de cuisine et de la salle de bain sont donnés à titre indicatif et sont non contractuels.