





















LEGENDE

	Emplacement Evier
	Emplacement Cuisson
	Emplacement Réfrigérateur
	Emplacement LL/LV
	Tableau Electrique
	Volet roulant
	Gaine technique
	Soffite Faux Plafond
	Cloison démontable
	Tablette
	Masquette
	Placards
	PF Porte fenêtre 3 vantaux dont un fixe
	PF Porte fenêtre 2 vantaux
	PF Porte fenêtre 1 vantail
	BF Baie fixe
	FE Fenêtre
	FV Fenêtre
	Panneau rayonnant
	Sèche serviette
	Prise TV

PRINCIPE DE CHANGEMENT DE NIVEAU INT/EXT

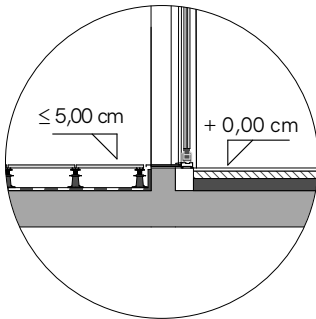

NOTA :

Des modifications sont susceptibles d'être apportées à ce plan en fonction des nécessités techniques, de la réalisation tant en ce qui concerne les dimensions libres que l'équipement. Les surfaces sont approximatives. Les retombées, soffites, faux plafond, équipements sanitaires ainsi que le calepinage et dimensions des carrelages sont figurés à titre indicatif, et peuvent subir des modifications pour impératif technique. Les appareils ménagers ne sont pas fournis. Les volets roulants seront prévus conformément à la notice de vente. Les coffres de volet roulant ne sont pas représentés et seront débordants à l'intérieur. La hauteur des seuils au droit des portes-fenêtres sur balcons ou terrasses pourra varier de 5 à 35cm à partir du sol intérieur. La hauteur entre le jardin et la terrasse pourra varier entre 0 et 60cm. Les jardins ne seront pas nécessairement plats et pourront comporter des talus et des pentes.

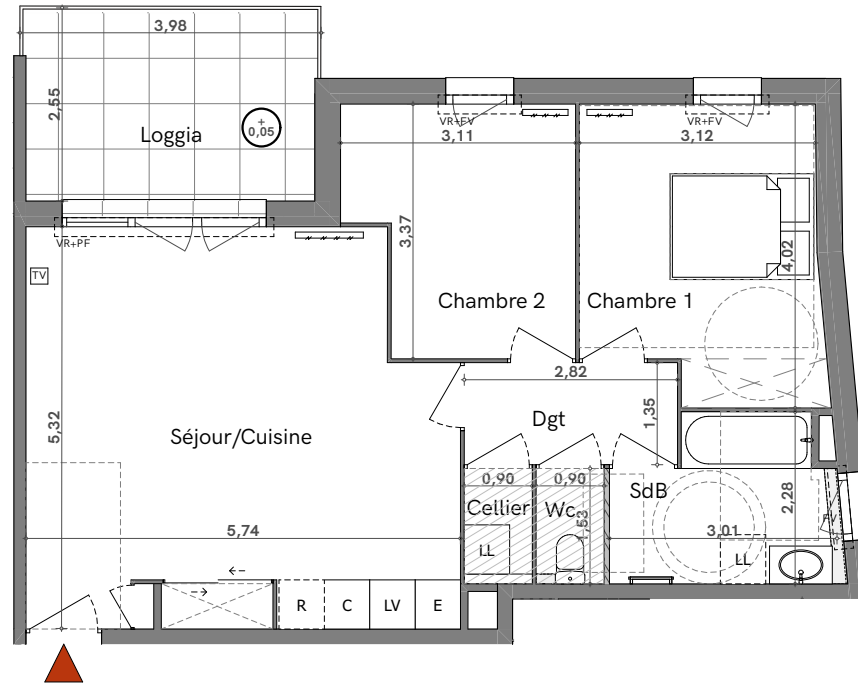

Terralys

PLAN DE PRÉ-COMERCIALISATION

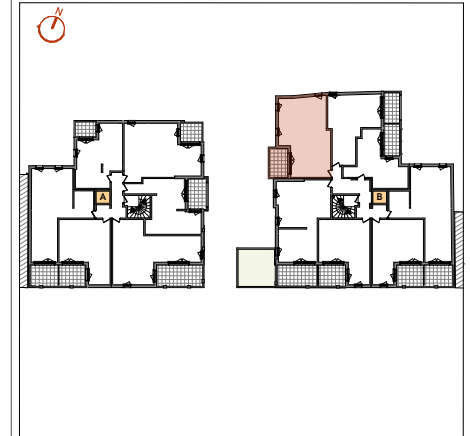

Niveau	Type	n° Appartement
R+1	T3	B102

TABLEAU DES SURFACES m²

(Compris placards)

Séjour/Cuisine	28,5
Chambre 1	11,8
Chambre 2	9,2
SdB	6,0
Dgt	3,8
Wc	1,4
Cellier	1,4
SURFACE HABITABLE	62,1 m²
Loggia	9,6
Surface Extérieure	9,6 m ²
SURFACE TOTALE	71,7 m²

 **LES NOUVEAUX CONSTRUCTEURS**

MN-LAB
 Mary & Nègre
 Architectes

CORIM
 PROMOTEUR CONSTRUCTEUR

INDICE B

29/08/2024